ANNEX A: STATEMENT OF WORK (SOW): RFP/HCR/KAD/SUP/2022/09

1. Background

UNHCR implements activities aimed at strengthening protection and inclusion for women and girls from refugee, host, and IDP communities. From this perspective, one of the core activities that support and strengthen women is the construction of women's centers in the targeted location within Gubyeish/Babanosa localities. This woman's center contains the following:

- Guardroom
- Training hall
- Counseling room
- Store
- Office
- Activity room/waiting room

With about 190 square meters of total building area, each women's center will contain general services facilities such as latrine ('Ventilated improved pit latrine', considering gender diversity and people with disabilities) with hand washing basins.

Concerning water supply, an elevated water tank supplied from a connection pipeline from the nearest water yard will be installed, and those centers will be electrically powered using solar energy.

In the design of women's centers a lot of consideration related to the protection of disabled people were taken to facilitate their movement to be active in their participation, ramps with handrails, even in latrine there is one instance especially designed for people with disabilities.

2. General Information

- The contractor should visit the sites before submitting the offer and get acquainted with the type of work required, the nature of the area, securing of supplying materials to the site, and keeping them stored safely.
- The contractor shall submit samples/descriptions/specifications of the materials to be used in the project to the UNHCR supervisor engineer, for approval, before the commencement of works. The supervisor engineer can reject any material that will not comply with the specifications, and be replaced by the contractor without extra cost, or the supervisor engineer can ask for any test to ensure the quality of the material used and work. The contractor has no right to change or draw any samples or materials being submitted and approved from the site without written permission from the supervisor engineer
- Work should be completed within a period of ninety (90) calendar days.
- The contractor shall commence working within 7 calendar days from the date of signature of the contract and deliver the site.
- After completion of works, a guarantee period of six (06) calendar months will apply.
- All works will be supervised by a supervisor engineer or supervisor engineers nominated by UNHCR
- The contractor shall appoint a qualified supervisor construction engineer with at least three years of professional experience to work full-time on the site during the contract period.
- The contractor shall prepare a detailed plan of the works upon handover of the site and signing of the contract before commencement of the work and should as well submit periodically progress reports to the supervisor engineers of UNHCR.
- The workmanship will be assessed after completion, upon which UNHCR will consider further cooperation with the company involved.
- The site shall be handed over in a clean environment condition.

3. Scope of Work

The Statement of Work has undertaken the following:

1. Construction Works:

1.1. The contractor should mobilize his labor, a mobile workshop to be used for fixing maintenance. and repairing any kind of work such as steel, carpentry ...etc.

1.2. The contractor should do clearing for the site after completing the whole Job and before handover.

1.3. Excavation Works:

1.3.1. The contractor should perform excavation to the required depth for the foundation 50(width)*70(depth)cm with disposal of excavation away or selected approved area.

1.4. Foundation Works:

1.4.1. The contractor should Supply material and lay a stone foundation with c/s mortar (1:8) 50 cm depth by 2 stages 25 cm each.

1.5. The contractor should supply materials and build a red brick continue foundation (two bricks system) with c/s mortar (1:6) width of wall 40cm, Hight 40 cm.

1.6. Concrete Works:

Supply materials and cast reinforced concrete Grade beam (1:2:4) with 6 steel 12mm bars for continuous foundation 30*40cm and use 8mm steel bar for Stirrup, rate to include conc. steel, formation work, steel work, and related works, as per normal standards and UNHCR engineer instruction.

1.6.1. Supply materials and cast reinforced concrete (1:2:4) with 4Ø12mm steel bars for tie beams 30*20cm and use 8mm steel bar for Stirrup @ 200 mm, rate to include concrete, steel, formwork, steel work, and all related works, as per normal standard and UNHCR engineer instruction.

1.6.2. Supply materials and cast reinforced concrete (1:2:4) with 4Ø12mm steel bars for ring beam 30*20cm and use 8mm steel bar for Stirrup @ 200 mm, rate to include concrete, steel, formwork, steel work, and all related works, as per normal standard and UNHCR engineer instruction.

1.7. Masonry Works:

1.7.1. The contractor should supply materials and build a brick wall of red brick with c/c mortar (1:8) width of 30cm (one-and-a-half brick system) including a parapet, work to include all related works.

1.8. Floor Works:

1.8.1. The contractor should supply materials and fill the subbase layer of selected material underground slab of 40cm, including leveling, watering, and compaction by 2-layer 20cm each.

1.8.2. The contractor should supply materials and cast 10 cm thick concrete (1:3:6) for the ground slab, work including all related works.

1.9. Finishing Works:

1.9.1. The contractor should supply materials and plaster walls c/s mortar (1:6) for internal and external walls, including walls edge /corners plaster windows and doors sills, and all related works, and complete the job.

- 1.9.2. The contractor should supply materials and apply quick drying prime (internal walls only) two coats to make the surface of walls adhesive to receive new paint.
 - 1.9.3. The contractor should supply materials and apply paint (suitable for interior and exterior walls) and 2 layers of paint (selected color) (main blocks).
- 1.10. Roof Works:
- 1.10.1. The contractor should supply materials and fabricate a steel grid from rectangular steel pipes 4*8 cm and 6*3 cm 1mm, for roof support grids, the work includes fixing anti-rust paint, paint, fixing the tie beams using bolts and all necessary accessories the work includes supply materials and fix a preprinted corrugated sheets steel sheets .35mm the blue color, as shown in the design, fixing on the purlins, trusses drilled nails with washer and all necessary accessories.
 - 1.10.2. The contractor should supply and fix the suspended ceiling from gypsum board square tiles 60x 60 cm, Aluminum frames T profile, and the suspended hanging system, including aluminum L profile. sample to be presented prior to installation.
- 1.11. Doors and Windows:
- 1.11.1. The contractor should supply and fix a (180*220) size new solid steel door, locally made, using heavy steel for door and frames as in the attached design, covered with heavy steel sheet, price to include, fixing with hinges, locking system, painted., as per normal standard and UNHCR engineer instruction.
 - 1.11.2. The contractor should supply and fix a (120*220) size new solid steel door, locally made, using heavy steel for rectangular pipes for doors and frames as in the attached design, covered with heavy steel sheet, price to includes, fixing with hinges, locking system, painted., as per normal standard and UNHCR engineer instruction.
 - 1.11.3. The contractor should supply and fix a (3*220) size new solid steel door for the main gate, locally made, using heavy steel for the door and frames as in the attached design, covered with heavy steel sheet, price to include, fixing with hinges, locking system, paint, etc., as per normal standard and UNHCR engineer instruction.
 - 1.11.4. The contractor should supply material and fabricate (120*120) size new steel windows, locally made, using heavy steel for frames, covered with a ribbed steel plate with horizontal grills made of 4*8 cm pipes, price to include, fixing with hinges, locking system, paint, grills ...etc., as per normal standard and UNHCR engineer instruction.
- 1.12. Electrical Works:
- 1.12.1. The contractor should provide for supply, installation, and all cables required for complete electrical work including PVC conduits.
 - 1.12.2. The contractor should supply and install ceiling mounted sweep fan with all accessories like wall-mounted speed control, non-corrosive type blades, regulator, fan hook, extension rod, and all other accessories required. The Minimum fan-to-floor distance shall be 230cm. the rate should include PVC insulated conductors of 3x2.5mm² inside PVC conduit of 16mm diameter including junction boxes with covers and insulating screw cap connectors The work should include excavation, laying, and connection with cable cleats, the works include supplying and installing all needed accessories.

- 1.12.3. The contractor should supply, install and connect wall lights of neon type 2ft with 20 w in buildings as shown in the drawings with the wiring of 2x2.5mm² cable inside PVC conduit of 16mm diameter, the work includes digging and installing (installation before finishing works) and needed finishing works."
- 1.12.4. The contractor should supply and install an approved type of LED roof light lamp Lighting, 20 W, 12V-24V, the works include supplying and installing all needed accessories.
- 1.13. Fence Works:
- 1.13.1. The contractor should supply material and fabricate a chain link fence, 1.8-meter height. 3" steel pipes supporter @ 2 meters, fixed by 30 cm concrete base including all related works, especially the main and minor gates, as shown in drawings.
- 1.14. The contractor should supply materials and fill a sub-base layer of selected materials for the corridor (at the entrance), 40 cm in height, rate includes leveling, watering, and compaction by 2 layers 20 cm each, as per normal standard and UNHCR engineer instruction.
- 1.15. The contractor should supply materials and cast conc.3 Steps 150cm wide and 15 cm height @ (entrance), with length 3m, rate includes all related works, as per normal standard and UNHCR engineer instruction.
- 1.16. The contractor must supply materials and cast Construct 1 ramp for disabled people as shown in the drawing, with a slope of 1:08 a maximum length of 3.5-4 meters, and a width not less than 90 cm, handrails should also be installed to protect and facilitate the use of ramps, the work includes site cleaning before and after construction and all necessary finishing works, as per normal standard and UNHCR engineer instruction.
- 1.17. Latrines (5 Stances):
- 1.17.1. The contractor should perform excavation work of the pit with dimensions (3*3*6) m, the work includes disposal of excavated materials to an approved area away from the site location.
- 1.17.2. The contractor should supply and construct a pit lining with (1.5) bricks with cement mortar (1:8) including dividing walls.
- 1.17.3. The contractor should Supply and cast concrete (1:3:6) for the pit and floors (10cm) and makes cement coating.
- 1.17.4. The contractor should Supply and make a plaster with cement mortar (1:6) for the inside of the pit.
- 1.17.5. The contractor should perform Excavation of the foundation trench (0.5*0.5), the work includes disposal of excavated materials to an approved area away from the site location.
- 1.17.6. The contractor should supply and construct a single-brick wall with cement mortar (1:8) for rooms (including divided walls).
- 1.17.7. The contractor should supply and a cast of concrete (1:2:4) for the door beam reinforced with steel bars 12mm (4 bars).
- 1.17.8. The contractor should supply, manufacture, and installation of zinc roofing corrugated steel sheet with 0.35 mm thick fixed by square pipes (4*8) including fixing bolts (4*8), the work

includes pre-painting, fixing on the rafters using all necessary plates, bolts, welding, and accessories.

1.17.9. The contractor should Supply and make plaster with cement mortar (1:8) for the walls inside and outside the rooms, isolation walls, and all parapets.

1.17.10. The contractor should Supply and install steel doors with a skylight size (0.7 * 2.2) meters for the doors of normal rooms.

1.17.11. The contractor should supply and install a steel door with a skylight size (1*2.2) meters for people with special needs room.

1.17.12. The contractor should Supply and paint the wall inside and out (the color is white with a blue stripe on the top line).

1.17.13. The contractor should supply and install ventilation pipes with cover for each stance.

1.17.14. The contractor should Supply and install facilities for people with disabilities:

- Iron seat.
- Ceramic hand washing basin.
- Handrail along the room.

1.17.15. The contractor should supply and install toilet ceramic seats of an approved type.

1.17.16. The contractor should supply material and construct a sub-base layer of selected material under the corridor ground slab of 35 cm, work includes leveling and compaction.

1.17.17. The contractor should supply materials and cast 10 cm thick plain concrete (1:3:6) for the corridor slab.

1.17.18. The contractor should construct of a ramp to the special needs people's room with a handrail.

1.17.19. The contractor should supply materials and build 2 basins for hand washing attached to latrines, with 2 water taps, the height should be suitable for disabled people, the work includes piping from the elevated water tank located in the women's center with all needed fittings.

1.18. External Floor Works:

The contractor should Supply materials and backfill the compound to ensure floor protection with the selected material height of 30cm, rate including leveling and compaction.

1.19. Feasibility Works:

The contractor should Supply and install a signboard (1 * 1) of meters of iron sheet, indicating the name of the project, the donor, and the implementer, the signboard should fix in a way to be visible.

4. Bill of Quantity (BOQ)

The specified job is all provisional, including the provision of materials and workmanship, providing water and electricity for the implementation and all other requirements to implement the job perfectly. cost of this item should be included /embedded in the other items. Below is the BOQ:

No.	DESCRIPTION	UNIT	QTY
1.0	MOBILIZATION		
1.1	Mobilization and Demobilization of labor/machinery workshop for fixing, fabrication, and maintaining of any kind of work such as formwork concrete, steel, carpentry ...etc.	JOB	1
2.0	SITE CLEARANCE		
2.1	Cleaning the site after completing the whole job and before handover.	JOB	1
3.0	BUILDINGS WORKS		
3.1	Excavation required depth for foundation 50(width)*70(depth)cm rate includes disposal of away or selected approved area, as per normal standard and UNHCR engineer instruction.	ML	114
3.2	Supply material and lay stone foundation with c/s mortar (1:8) 50 cm depth, 50 cm width, by 2 stages 25 cm each, as per normal standard and UNHCR engineer instruction.	ML	114
3.3	Supply materials and building red brick continue foundation (two bricks system) with c/s mortar (1:6) width of wall 40cm, height 40 cm, as per normal standard and UNHCR engineer instruction.	ML	114
3.4	Supply materials and cast reinforced concrete Grade beam (1:2:4) with 6 steel 12mm bars for continuous foundation 30*40cm and use 8mm steel bar for Stirrup, rate to include conc. steel, formation work, steel work, and related works, as per normal standards and UNHCR engineer instruction.	M3	13.68
3.5	Supply materials and build bricks wall of red brick with c/c mortar (1:8) width of 30cm (one and half brick system) including parapet, work to include all related works, as per normal standard and UNHCR engineer instruction	M2	324
3.6	Supply materials and cast reinforced concrete (1:2:4) with 4Ø12mm steel bars for tie beams 30*20cm and use 8mm steel bar for Stirrup @ 200 mm, rate to include concrete \, steel, formwork, steel work, and all related works, as per normal standard and UNHCR engineer instruction.	M3	6.84
3.7	Supply materials and cast reinforced concrete (1:2:4) with 4Ø12mm steel bars for ring beam 30*20cm and use 8mm steel bar for Stirrup @ 200 mm, rate to include concrete, steel, formwork, steel work, and all related works, as per normal standard and UNHCR engineer instruction.	M3	6.84
3.8	Supply materials and fill sub-base layer of selected material underground slab of 40cm, rate includes leveling, watering, and compaction by 2 layers 20cm each, as per normal standard and UNHCR engineer instruction.	M3	75.2
3.9	Supply materials and cast 10 cm thick concrete (1:3:6) for the ground slab, including a steel grid with 8 mm steel bars at 20 cm in both directions, (including the waiting area) work including all related works, as per normal standard and UNHCR engineer instruction.	M2	188
3.10	Supply materials and plaster walls c/s mortar (1:6) for internal and external walls, rate include walls edge /corners plaster windows and doorsills and all related works, complete job, as per normal standard and UNHCR engineer instruction.	M2	200
3.11	Supply materials and fabricate steel grid from rectangular steel pipes 4*8 cm and 6*3 cm 1mm, for roof support grids, the work includes fixing, anti-rust paint, and paint, fixing on the tie beams using bolts and all necessary accessories the work includes supplying materials and fix a pre-painted corrugated sheets steel sheets .35mm the blue color, as shown in the design, fixing on the purlins, trusses drilled nails with washer and all necessary accessories, as per normal standard and UNHCR engineer instruction.	M2	188

3.12	Supply and fix suspended ceiling from gypsum board square tiles 60x 60 cm, and Aluminium frames T profile, and the suspended hanging system, including aluminum L profile. The sample is to be presented prior to installation, as per normal standard and UNHCR engineer instruction.	M2	188
4.0	DOORS AND WINDOWS		
4.1	Supply and fix (100*220) size new solid steel door, locally made, using heavy steel for door and frames as in attached design, covered with heavy steel sheet, price to include, fixing with hinges, locking system, paint,...etc, as per normal standard and UNHCR engineer instruction.	NO.	2
4.2	Supply and fix (120*220) size new solid steel door, locally made, using heavy steel for rectangular pipes for doors and frames as in the attached design covered with heavy steel sheet, price to include, fixing with hinges, locking system, paint,...etc, as per normal standard and UNHCR engineer instruction.	NO.	6
4.3	Supply material and fabricate (120*120) size new steel new windows, locally made, using heavy steel for frames, covered with a ribbed steel plate with horizontal grills made of 4*8 cm pipes, price to include, fixing with hinges, locking system, paint grills ...etc, as per normal standard and UNHCR engineer instruction.	NO.	23
5.0	FINISHING WORKS		
5.1	Supply materials and apply quick drying prime (internal walls only) two coats to make the surface of walls adhesive to receive new paint, as per normal standard and UNHCR engineer instruction.	M2	200
5.2	Supply materials and apply paint (suitable for interior and exterior walls) 2 layers of paint (selected color) (main blocks), rate includes all related works, as per normal standard and UNHCR engineer instruction.	M2	400
6.0	ELECTRICAL WORKS & EXTRA FINISHING WORKS		
6.1	Provide for supply, installation and all cables and sockets (as shown in drawings) required for a complete electrical work including PVC conduits provide armored connection cable from the building to the nearest power source. The rate should include excavation, laying, and connection with cable cleats, as per normal standards and UNHCR engineer instruction.	LS	1
6.2	Supply and install Ceiling mounted sweep fan with all Accessories like wall-mounted Speed Control, non-corrosive type blades, regulator, fan hook, extension rod, and all other accessories required. The minimum fan-to-floor distance shall be 230cm. The rate shall include PVC insulated conductors of 3x2.5mm ² inside PVC conduit of 16mm diameter including junction boxes with covers and insulating screw cap connectors The rate should include excavation, laying, and connection with cable cleats, as per normal standard and UNHCR engineer instruction.	LS	9
6.3	Light Fittings and Lamps: lamps Supply, install and connect wall lights of LED Wall lamps 15 w in buildings as shown in the drawings with the wiring of 2x2.5mm ² cable inside PVC conduit of 16mm diameter, the work includes digging installing (installation before finishing works), lamps key for opening and closing, and all needed finishing works, as per normal standard and UNHCR engineer instruction.	LS	22
6.4	Supply and install an approved type of LED roof light lamps Lighting, 15W. The rate should include fixing on the roof, installing keys for opening and closing, wiring, laying, and connection with cable cleats, as per normal standard and UNHCR engineer instruction.	LS	6
6.5	Supply material and fill sub-base layer of selected materials for the corridor, 50 m ² , 40 cm height, rate includes leveling, watering and compaction by 2 layers 20 each, as per normal standard and UNHCR engineer instruction.	M3	20
6.6	Supply and install concrete block (interlock) at the corridor, the total area is 50 m ² , the rate includes all needed works, as per normal standard and UNHCR engineer instruction.	M2	50

6.7	Supply materials and cast conc.3 Steps 150cm wide and 15 cm height @ (entrance), with length 1m, rate includes all related works, as per normal standard and UNHCR engineer instruction.	LS	1
6.8	Supply materials and cast Construct 1 ramp for disabled people as shown in the drawing, with a slope of 1:08 a maximum length of 3.5-4 meters, and a width not less than 90 cm, using 8mm steel bars, 15 cm mesh in both directions as fine reinforcement, handrails should also be installed to protect and facilitate the use of ramps, the work includes site cleaning before and after construction and all necessary finishing works, as per normal standard and UNHCR engineer instruction.	LS	1
7.0	FENCE WORKS		
7.1	Supply material and fabricate chain link fence as shown in the drawing, 1.8-meter height. 3" steel pipes supporter @ 2 meters, fixed by 40x40x50 cm concrete base rate attached to wire mesh 25cm and linked to steel pipes using Knot every 1m to ensure good fixing as shown in drawings, as per normal standard and UNHCR engineer instruction.	ML	41
7.2	Supply material and fabricate the main gate with a locking system linked to the fence as shown in the drawing,3m width (2 doors with support and lock in the middle), 1.8-meter height. 3" steel pipes for both frame and stands, fixed by 60x60x60 cm concrete base, rate including all needed works, as per normal standard and UNHCR engineer instruction.	LS	1
7.3	Supply material and fabricate pedestrian gate with locking system linked to the fence as shown in drawing,1.2m width, 1.8-meter height. 3" steel pipes for both frame and stands, fixed by 60x60x60 cm concrete base rate including all needed works as per normal standard and UNHCR engineer instruction.	LS	1
8.0	LATRINE (5 STANCE)		
8.1	Excavation of pit with dimensions (3*3*6) m, the work includes disposal of excavated materials to an approved area away from the site location, as per normal standard and UNHCR engineer instruction.	M3	54
8.2	Supply and construction of a pit lining with (1.5) bricks with cement mortar (1:8) including dividing walls, as per normal standard and UNHCR engineer instruction.	M2	63
8.3	Supplying and casting concrete (1:3:6) for the pit and floors (10cm) and making Cement coating, as per normal standard and UNHCR engineer instruction.	M2	26
8.4	Supplying and placing Reinforcement concrete (1:2:4) for the latrine slab using 12mm bars 12cm grid c/c for reinforcement, as per normal standard and UNHCR engineer instruction.	M2	18
8.5	supplying and making a plaster with cement mortar (1:6) for the inside of the pit, as per normal standard and UNHCR engineer instruction.	M2	90
8.6	Excavation of foundation trench (0.5*0.5), the work includes the disposal of excavated materials to an approved area away from the site location, as per normal standard and UNHCR engineer instruction.	ML	40
8.7	Supply and construction of a single-brick wall with cement mortar (1:8) for rooms (including divides walls), as per normal standard and UNHCR engineer instruction.	M2	67.5
8.8	Supply and casting of concrete (1:2:4) for the door beam reinforced with steel bars 12mm (4 bars), as per normal standard and UNHCR engineer instruction.	ML	24
8.9	Supply, manufacture, and installation of zinc roofing corrugated steel sheet with 0.35 mm thick fixed by square pipes (4*8) including fixing bolts (4*8), the work includes pre-painting, fixing on the rafters using all necessary plates, bolts, welding, and accessories, as per normal standard and UNHCR engineer instruction.	M2	15

8.10	Supplying and making plaster with cement mortar (1:8) for the walls inside and outside the rooms, isolation walls, and all parapets, as per normal standard and UNHCR engineer instruction.	M2	126
8.11	Supplying and installing steel doors with a skylight size (0.7 * 2.2) meters for the doors of normal rooms, as per normal standard and UNHCR engineer instruction.	No	4
8.12	Supply and installation of a steel door with a skylight size (1*2.2) meters for people with special needs room, as per normal standard and UNHCR engineer instruction.	No	1
8.13	Supplying and painting the wall inside and out (the color is white with a blue stripe on the top line, as per normal standard and UNHCR engineer instruction.	M2	126
8.14	Supply and installation of ventilation pipes with meshed cover.	No	5.0
8.15	Supplying and installing facilities for people with disabilities, -iron seat, -handrail along the room. as per normal standards and UNHCR engineer instruction.	LS	1.0
8.16	Supplying and installing toilet ceramic seats of an approved type, as per normal standard and UNHCR engineer instruction.	No	5.0
8.17	Supply material and construct a sub-base layer of selected material under the corridor ground slab of 35 cm, work includes leveling and compaction, as per normal standard and UNHCR engineer instruction.	M3	4.0
8.18	Supply materials and cast 10 cm thick plain concrete (1:3:6) for corridor slab, as per normal standard and UNHCR engineer instruction.	M3	1.5
8.19	Supply and construction of a ramp to special need people room with handrail, as per normal standard and UNHCR engineer instruction.	No	1.0
9.0	EXTERNAL FLOOR		
9.1	Supply materials and backfill of the compound to ensure floor protection with the selected material height of 30cm, rate including leveling and compaction, as per normal standard and UNHCR engineer instruction.	M2	204
10.0	HANDWASHING BASIN		
10.1	Supply materials and build 2 basins for hand washing attached to latrines, with 2 water taps, the height should be suitable for disabled people, the work includes piping from the elevated water tank located in the women center with all needed fittings, as per normal standard and UNHCR engineer instruction.	LS	1.0
11.0	FESIBILITY WORKS		
11.1	Supplying and installing a signboard (1 * 1) meters of iron sheet, indicating the name of the project, the donor, and the implementer, as per normal standard and UNHCR engineer instruction.	No	1.0

5. Site Drawings:

Below are the site drawings:

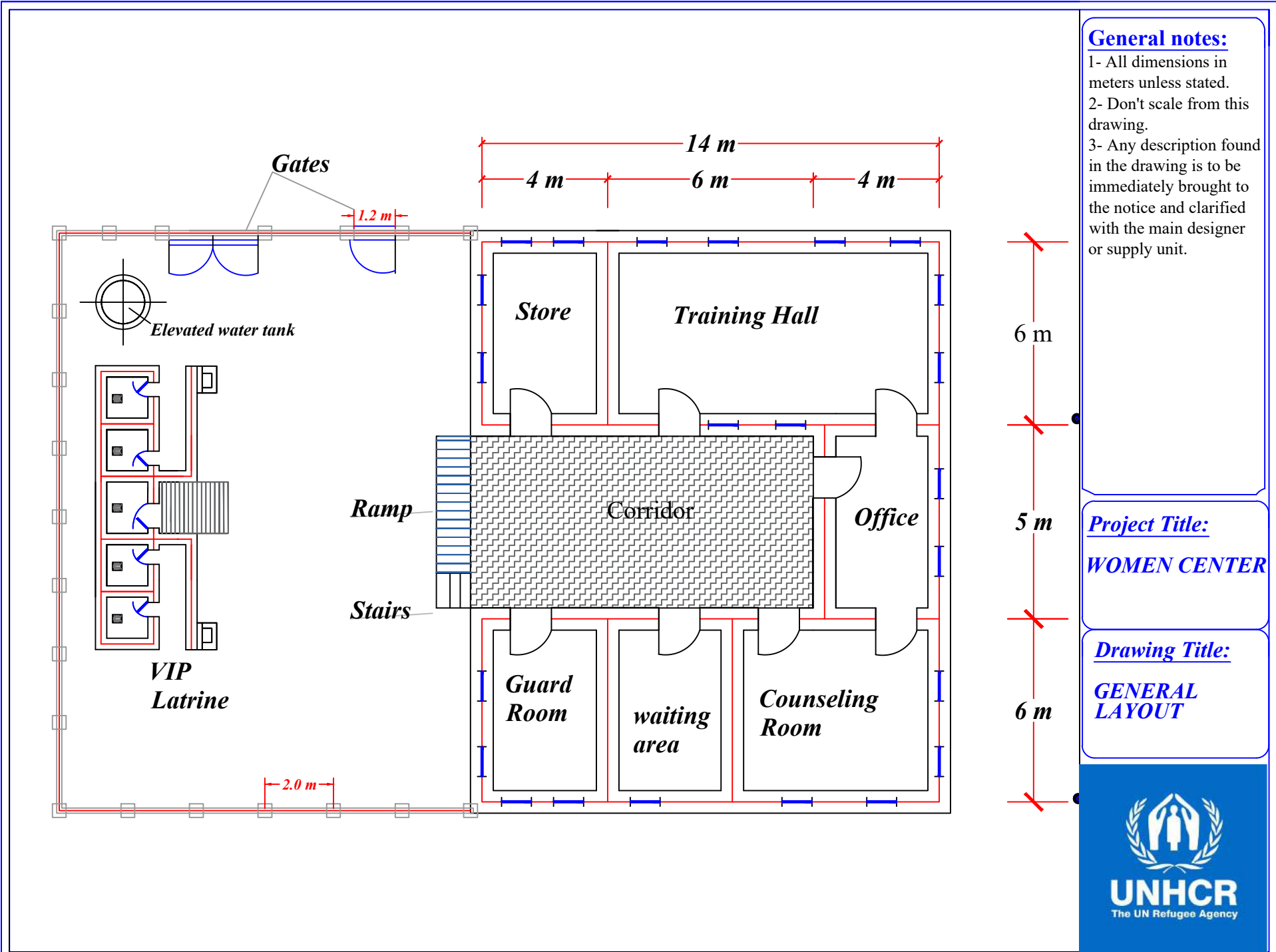

General notes:

- 1- All dimensions in meters unless stated.
- 2- Don't scale from this drawing.
- 3- Any description found in the drawing is to be immediately brought to the notice and clarified with the main designer or supply unit.

Project Title:

WOMEN CENTER

Drawing Title:

GENERAL LAYOUT



Section B-B

Section A-A

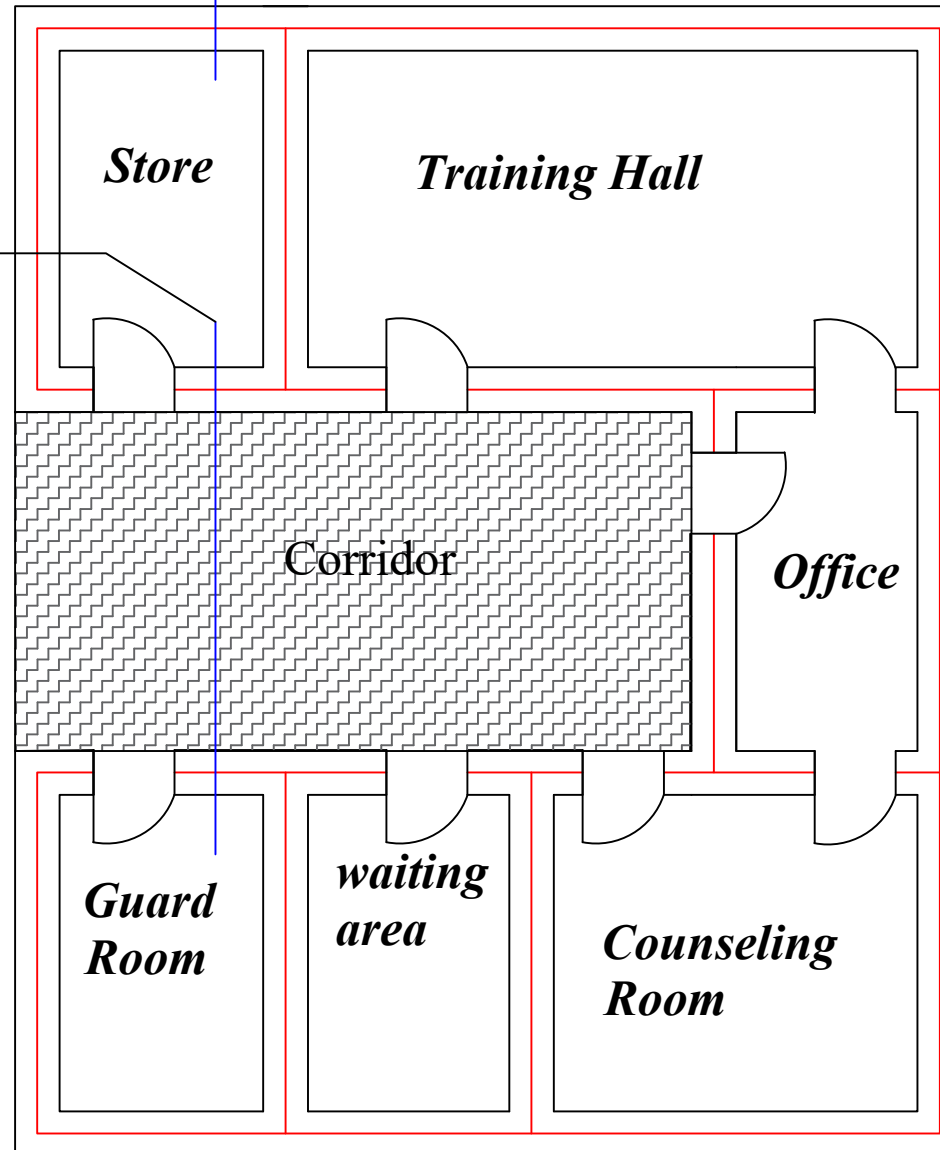

General notes:

- 1- All dimensions in meters unless stated.
- 2- Don't scale from this drawing.
- 3- Any description found in the drawing is to be immediately brought to the notice and clarified with the main designer or supply unit.

Project Title:

WOMEN CENTER

Drawing Title:

GENERAL LAYOUT



UNHCR
The UN Refugee Agency

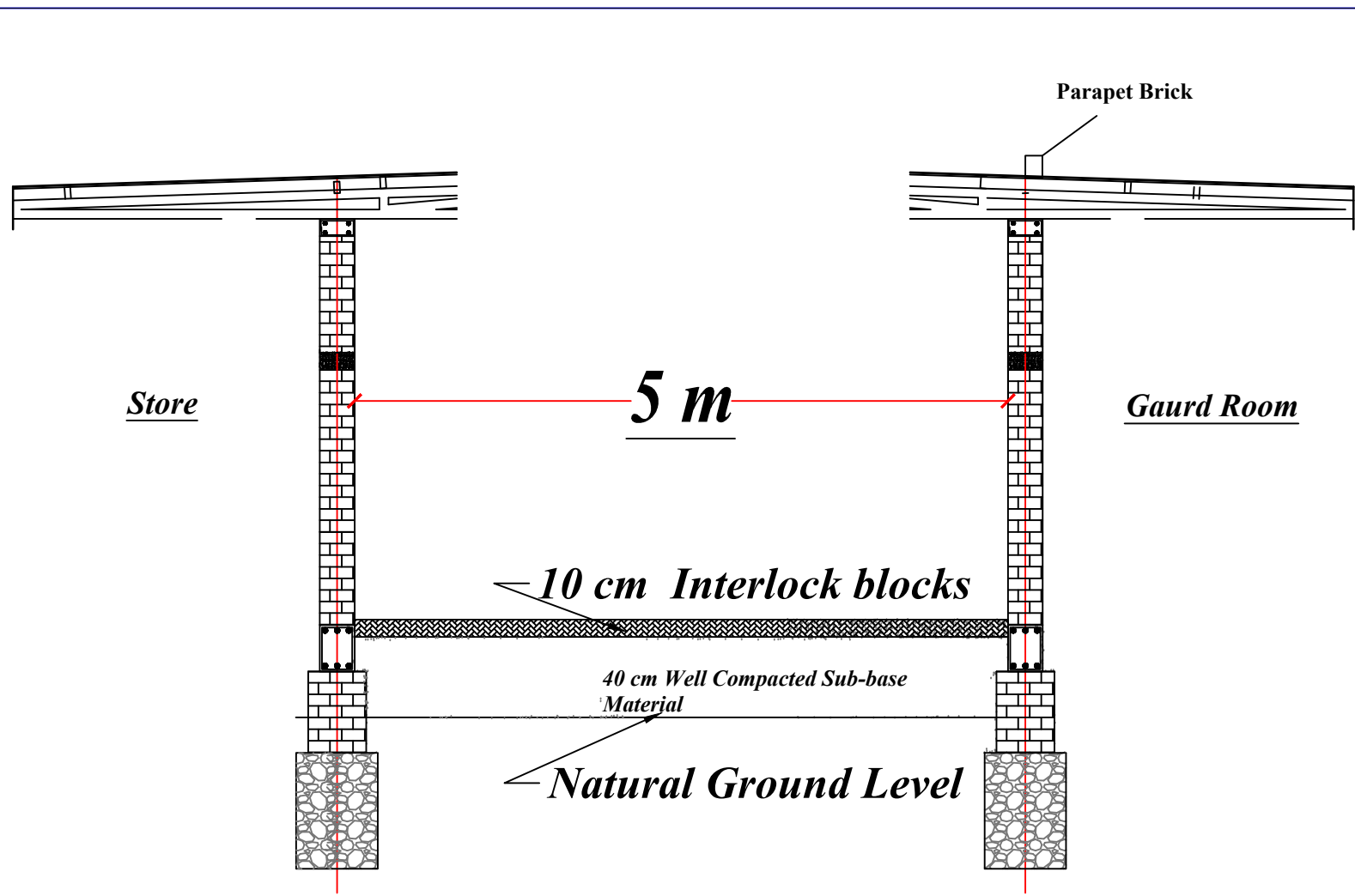

Section A-A

General notes:

- 1- All dimensions in meters unless stated.
- 2- Don't scale from this drawing.
- 3- Any description found in the drawing is to be immediately brought to the notice and clarified with the main designer or supply unit.

Project Title:

WOMEN CENTER

Drawing Title:

Section A-A



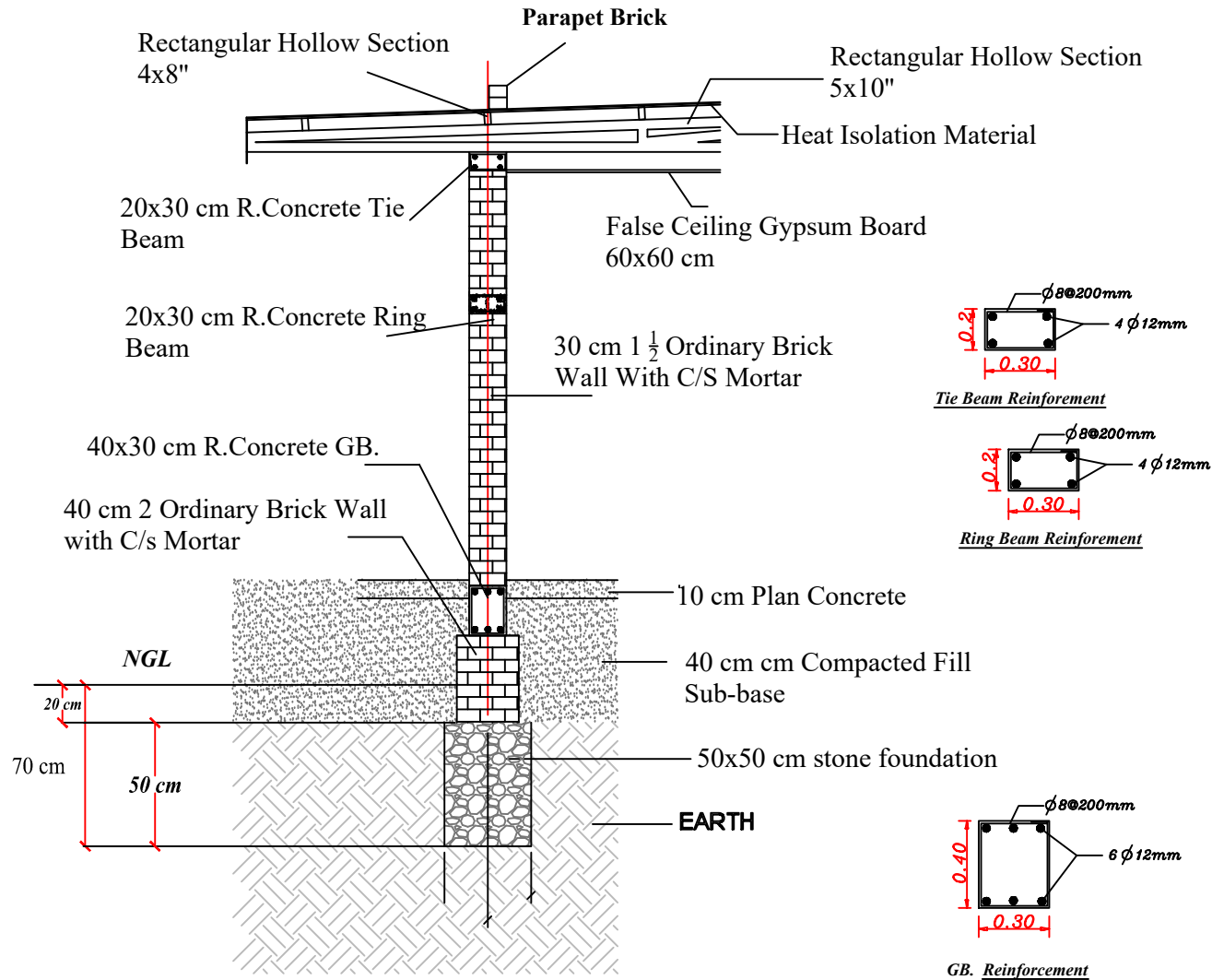

Section B-B

General notes:

- 1- All dimensions in meters unless stated.
- 2- Don't scale from this drawing.
- 3- Any description found in the drawing is to be immediately brought to the notice and clarified with the main designer or supply unit.

Project Title:

WOMEN CENTER

Drawing Title:

Section B-B



UNHCR
The UN Refugee Agency

Roof slope direction

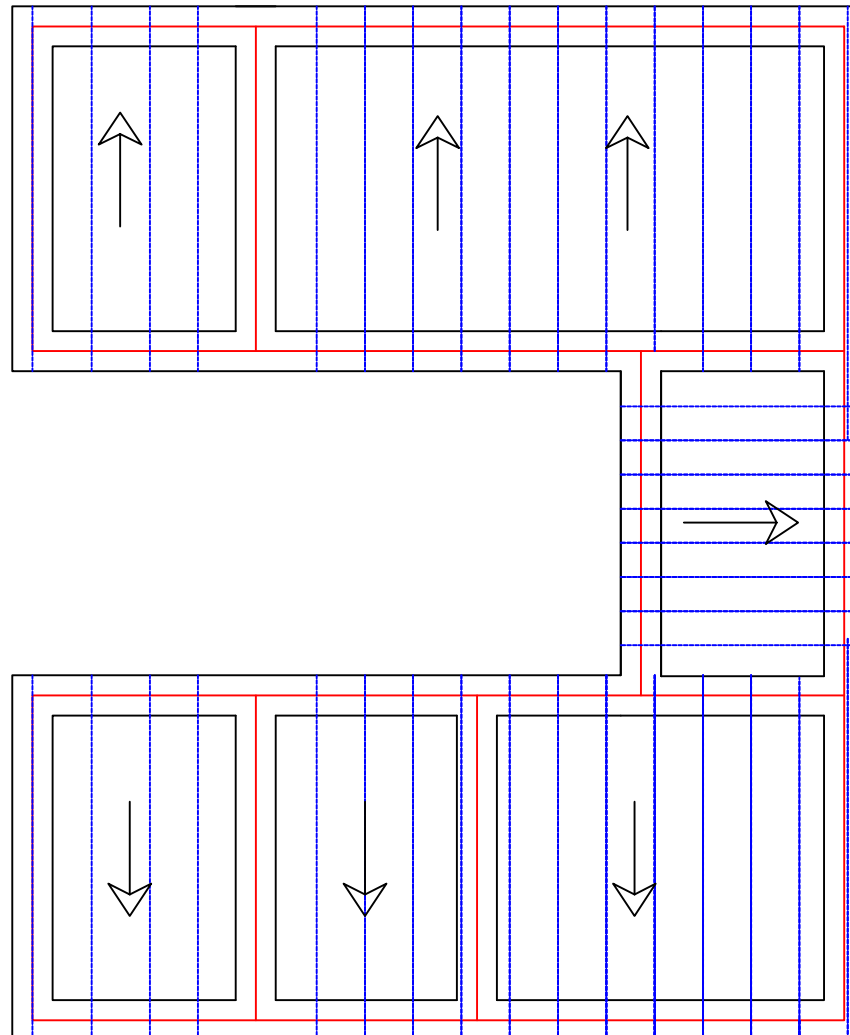

General notes:

- 1- All dimensions in meters unless stated.
- 2- Don't scale from this drawing.
- 3- Any description found in the drawing is to be immediately brought to the notice and clarified with the main designer or supply unit.

Project Title:







WOMEN CENTER

Drawing Title:

Buildings roof slope



UNHCR
The UN Refugee Agency

KEY LEGEND	
ITEM	DESCRIPTION
	Ceiling Lamp
	Ceiling Fan
	Wall Lamp
	Lamp Key
	Socket
	Control panel

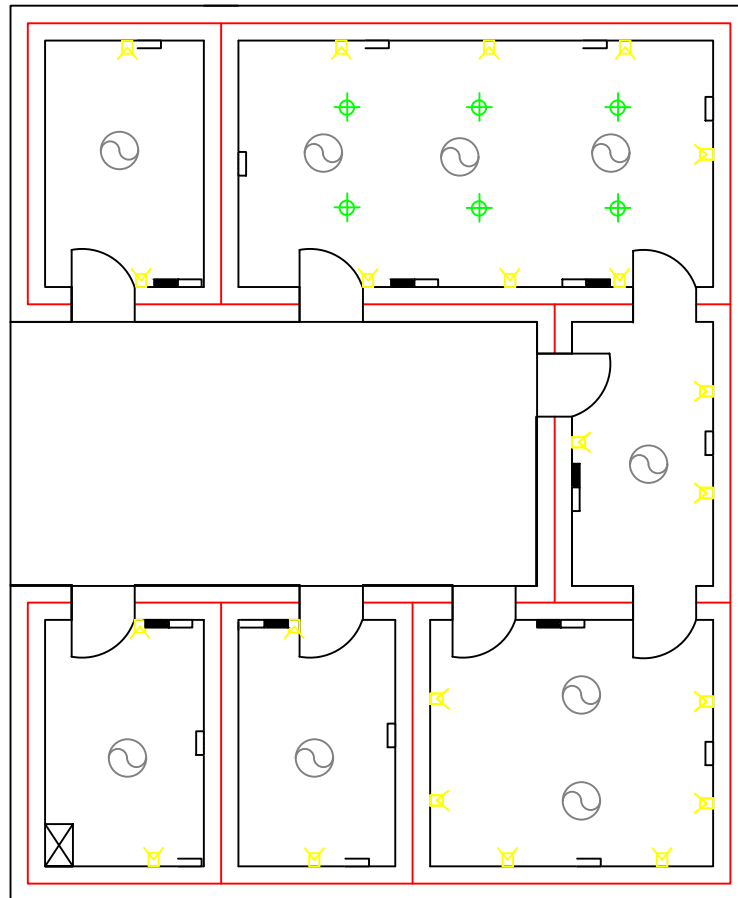

General notes:

- 1- All dimensions in meters unless stated.
- 2- Don't scale from this drawing.
- 3- Any description found in the drawing is to be immediately brought to the notice and clarified with the main designer or supply unit.

Project Title:

WOMEN CENTER

Drawing Title:

Electrical Details



UNHCR
The UN Refugee Agency

1.2 m 1.2 m 1.5 m 1.2 m 1.2 m

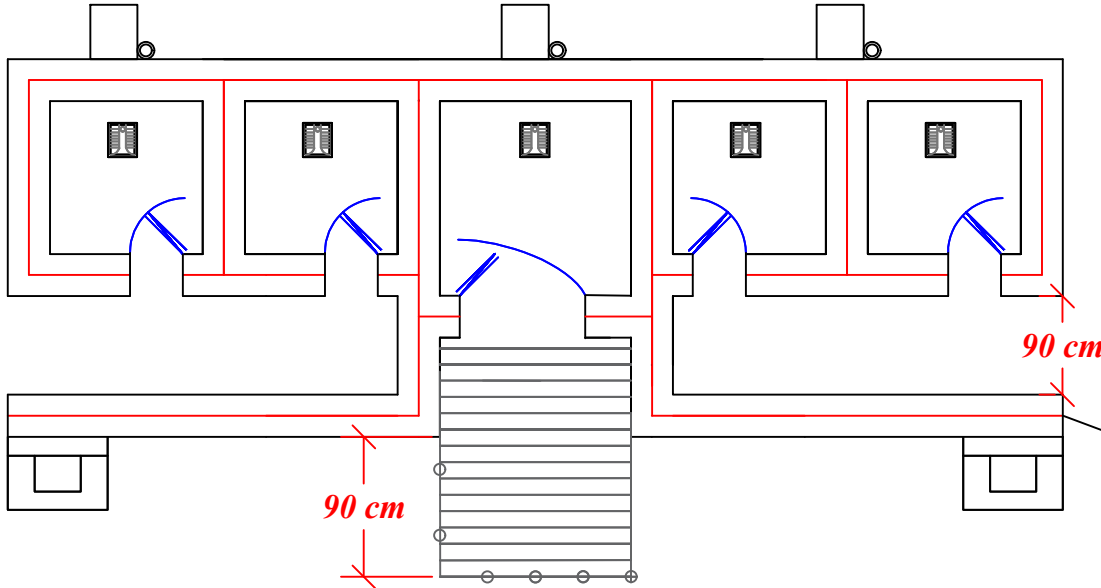

Ramp with 1:0.08 slope

**Privacy wall
with 1.5m
height**

General notes:

- 1- All dimensions in meters unless stated.
- 2- Don't scale from this drawing.
- 3- Any description found in the drawing is to be immediately brought to the notice and clarified with the main designer or supply unit.

*Project Title:
Women Center*

*Drawing Title:
Latrine- Plan*



General notes:

- 1- All dimensions in meters unless stated.
- 2- Don't scale from this drawing.
- 3- Any description found in the drawing is to be immediately brought to the notice and clarified with the main designer or supply unit.

Project Title:

Women Center

Drawing Title:

Latrine-side view

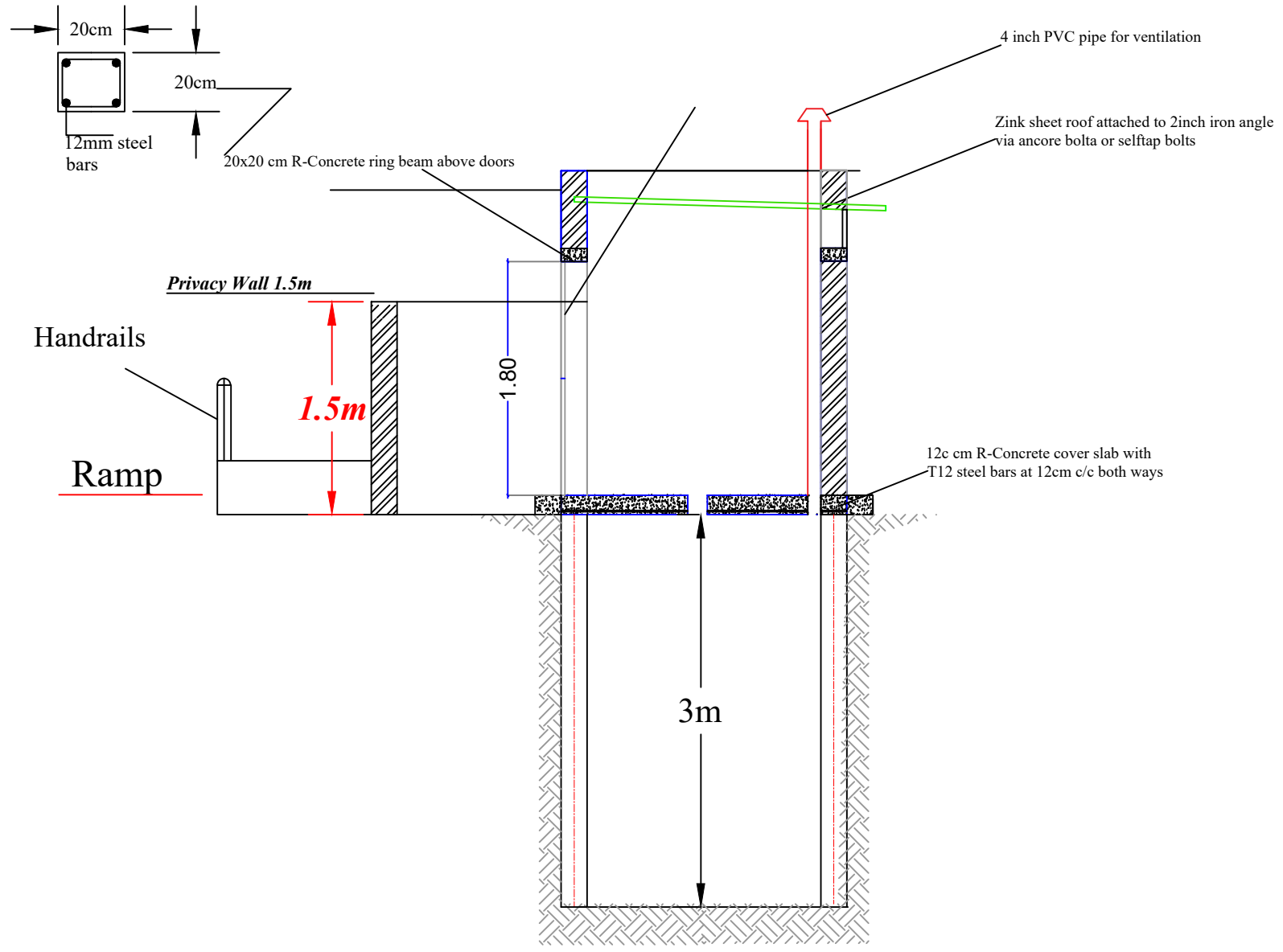

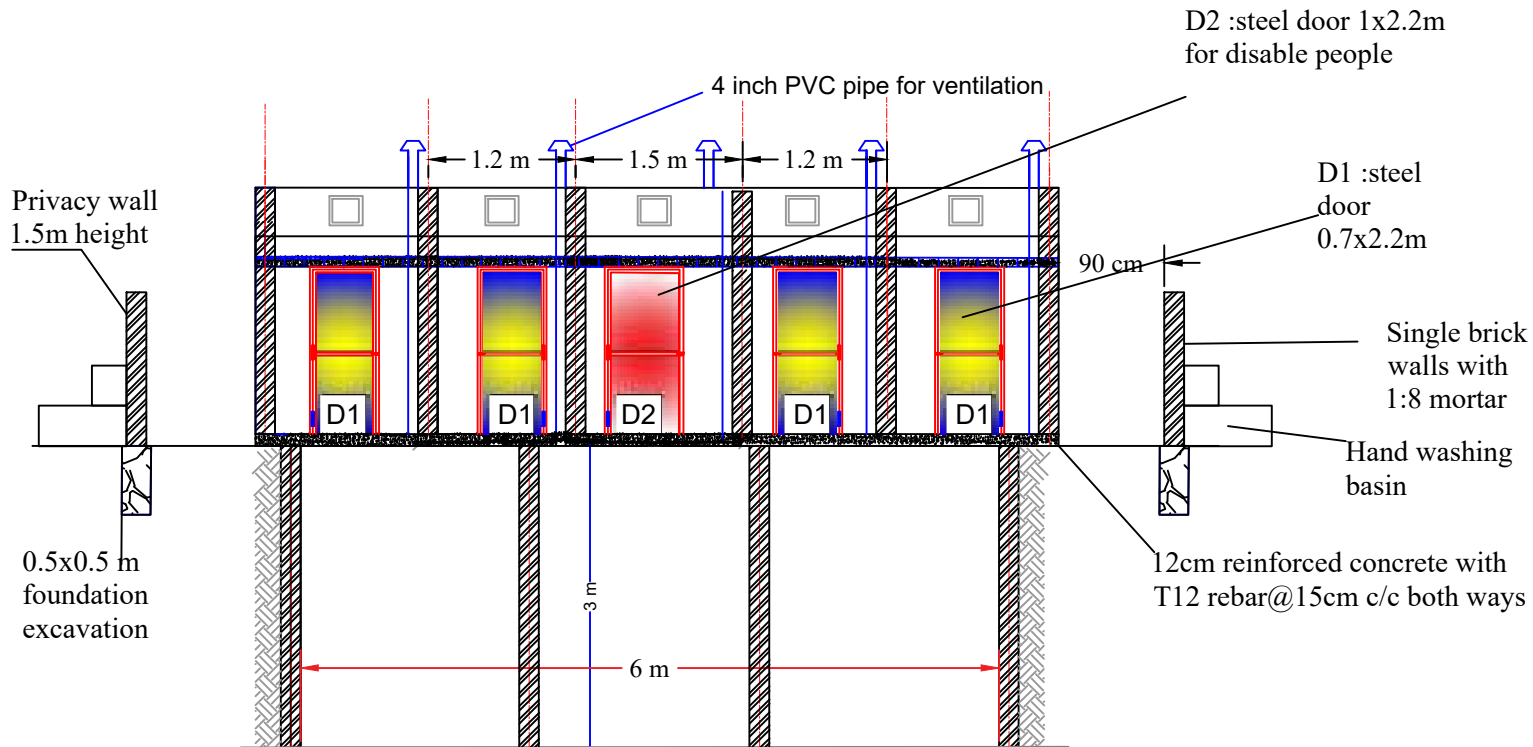

General notes:

- 1- All dimensions in meters unless stated.
- 2- Don't scale from this drawing.
- 3- Any description found in the drawing is to be immediately brought to the notice and clarified with the main designer or supply unit.

Project Title:

Women Center

Drawing Title:

Latrine-Front view



UNHCR
The UN Refugee Agency

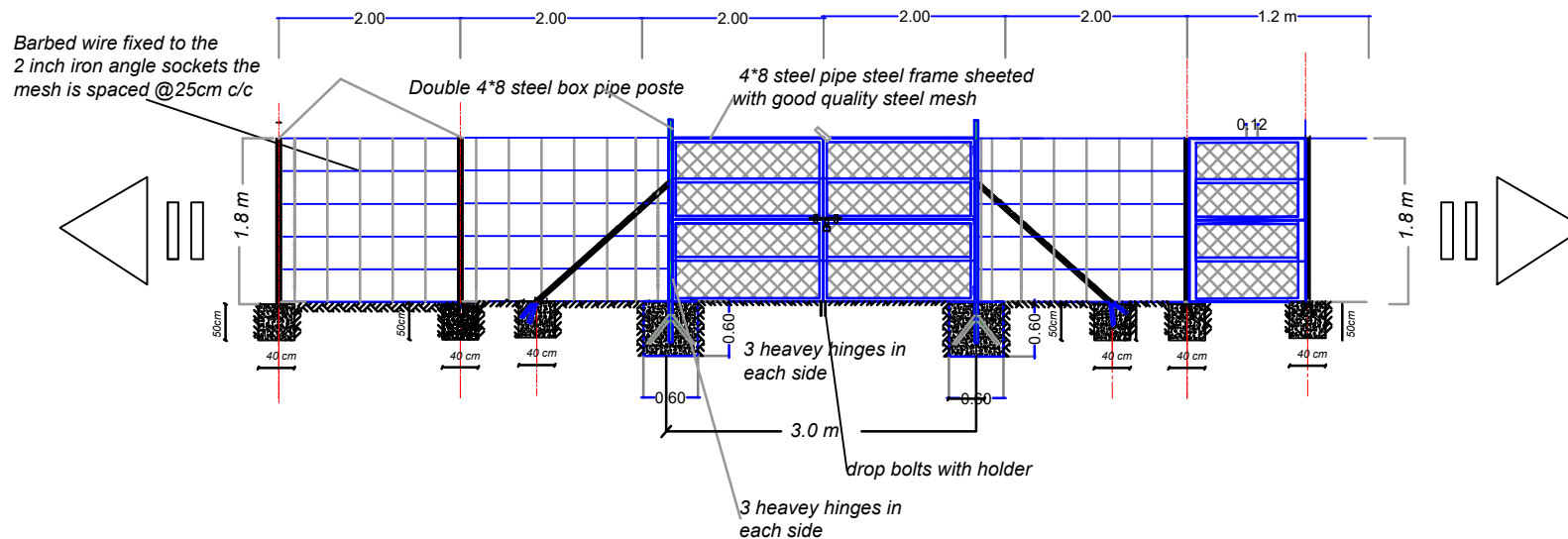
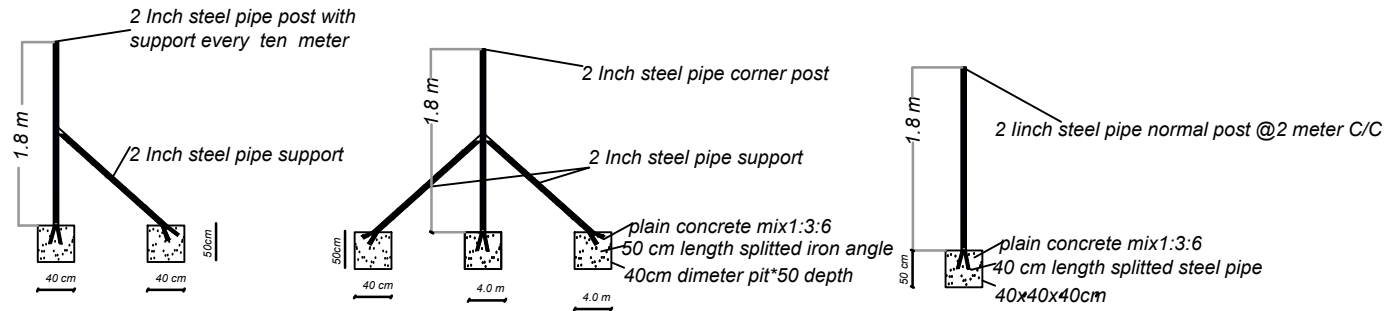

General notes:

- 1- All dimensions in meters unless stated.
- 2- Don't scale from this drawing.
- 3- Any description found in the drawing is to be immediately brought to the notice and clarified with the main designer or supply unit.

Project Title:

Women Center

Drawing Title:

Fence-Detail2



UNHCR
The UN Refugee Agency

